

SPICE thermal model

PSMN6R0-25YLD

Symbol	Parameter	Conditions	Min	Typ	Max	Unit
$R_{th(j-mb)}$	thermal resistance from junction to mounting base		-	-	4.36	K/W

C_{th1}	6.899E-06 F
C_{th2}	6.734E-05 F
C_{th3}	9.196E-05 F
C_{th4}	6.980E-04 F
C_{th5}	6.110E-04 F
C_{th6}	6.934E-03 F
C_{th7}	9.152E-03 F
R_{th1}	7.092E-03 Ω
R_{th2}	1.538E-02 Ω
R_{th3}	6.973E-02 Ω
R_{th4}	1.774E-01 Ω
R_{th5}	6.340E-01 Ω
R_{th6}	1.964E+00 Ω
R_{th7}	1.493E+00 Ω

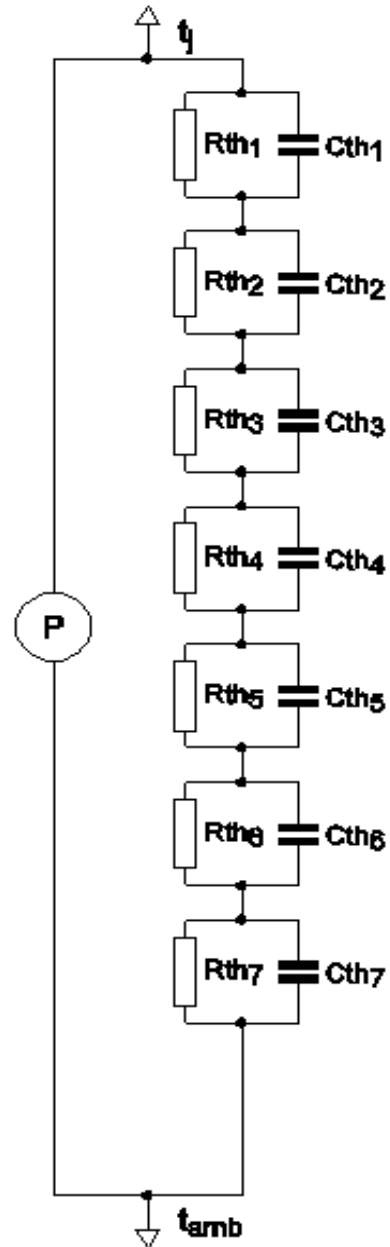

Part: PSMN6R0-25YLD
 Date: 22/3/2016
 Model Rth 4.36 K/W